

# WARD

The first Zoom Profile Spotlight with Ring Control



*The Magic of the Rings...*

A major Innovation for  
Stage Lighting Professionals

**ADB**  
Lighting Technologies

# WARD !

## The Power of the Rings...

- 12°-30° and 22°-50° zoom profiles
- 800 W halogen axial lamp, 230 V, 3200 °K, G9.5
- Light output higher than with a 1200 W conventional profile
- Dichroic glass reflector for low gate and beam temperature
- B size gate for maximum gobo definition
- Innovative ring control of focus, zoom, iris, gobo and shutters
- Individual 360° rotation of shutters and gobos
- Access to all controls from any position around the spotlight
- Independent lamp position and spot / even adjustments
- Holder for one iris diaphragm + one 360° rotating gobo (or two gobos without iris)
- Stepless yoke positioning along the spotlight for balance adjustment
- Innovative, compact, robust, ergonomic design

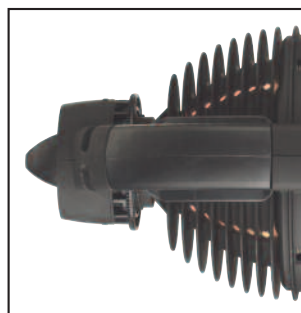

# WARD ! The Comfort of the Rings...

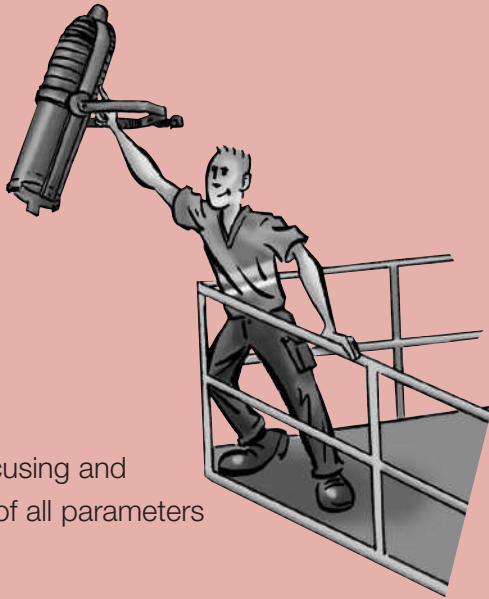

Ground focusing and  
presetting of all parameters



Easy fingertip control of zoom,  
focus, iris, gobo and shutters from  
any position

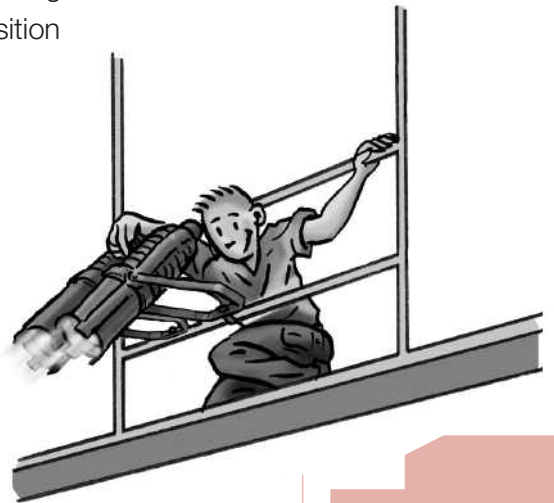
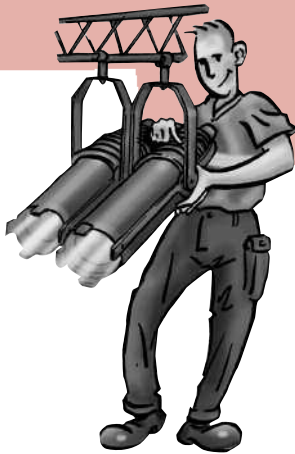

A solution for hard-to-reach spots  
and confined space operation

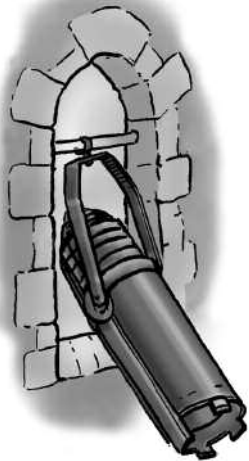

*WARD will make your job easier !*

# WARD !

## The Secret of the Rings...

Conventional shutters replaced by 4 integrated blades, each with 360° endless rotation capability... to extend the limits of your creativity



No more cumbersome shutters  
in the way = easier handling  
No more buckled or lost shutters

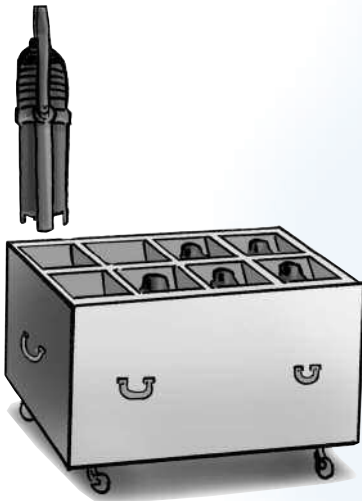

Stable settings, non sensitive to vibrations  
Compact body = more lights on a bar and  
reduced storage space

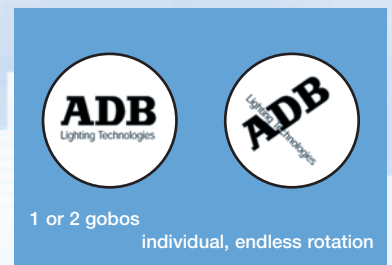
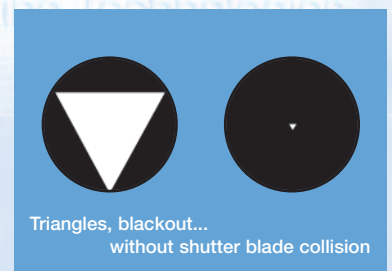
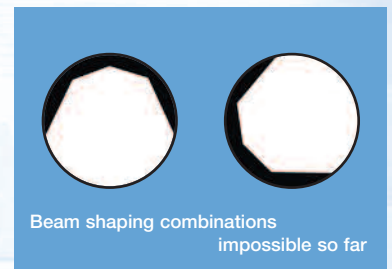
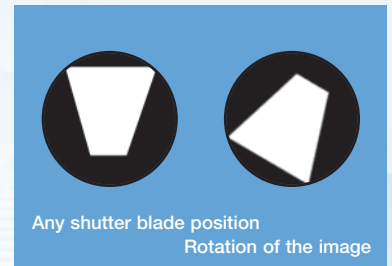
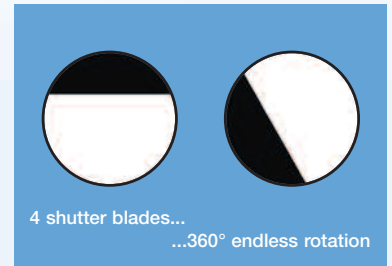

### Gobo Holders and Iris Diaphragms

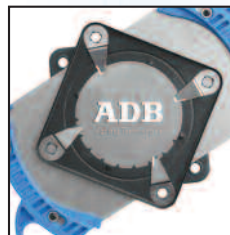
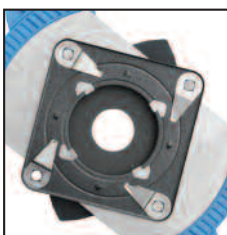

# WARD!

## The Light of the Rings...

### WARD 12°-30°

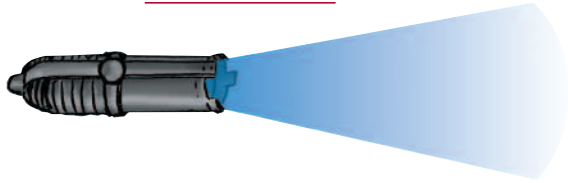

### WARD 22°-50°

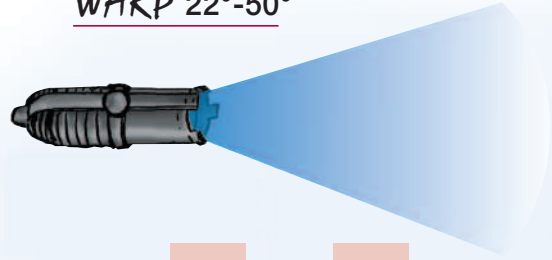

				At min. angle				
10	15	20	25	Distance (m)	8	10	14	18
2.6	3.9	5.3	6.6	Field Ø (m)	3.5	4.4	6.2	8
3900	1733	975	624	Illumination (lux)	2500	1600	816	494
				At max. angle				
5	8	11	14	Distance (m)	3	5	7	9
2.7	4.3	5.9	7.5	Field Ø (m)	2.7	4.5	6.2	8.0
3960	1547	818	505	Illumination (lux)	4388	1580	806	488

\* Typical values measured at 230 V with a 800 W / 20.000 lm lamp

	WARD 12°-30°	WARD 22°-50°
Net/gross weight	12.2/14 kg	11/13.5 kg
Packing	819 x 328 x 365 mm	
Units per pallet	12	12

Supplied with:

- dichroic glass reflector
- 2 zoom lenses with anti-reflection coating
- **patented ring control of all functions**
- G 9.5 lampholder for axial lamp 800 W/230 V
- 1.6 m power supply cable without plug
- 1 metal filter frame (185 x 185 mm)

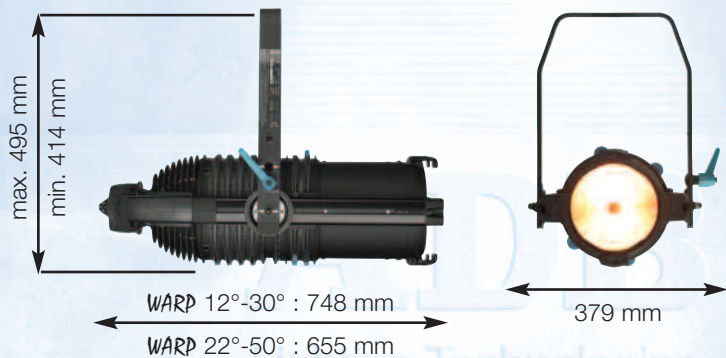

- WARD zoom profile spotlight 12° - 30° / 230 V
- WARD zoom profile spotlight 22° - 50° / 230 V
- WARD zoom profile spotlight 12° - 30° / 90 - 264 V
- WARD zoom profile spotlight 22° - 50° / 90 - 264 V

#### Accessories

- Metal filter frame (185 x 185 mm)
- Safety grid (185 x 185 mm)
- Double gobo holder (rotating) type B
- Combined iris diaphragm & gobo holder (rotating) type B
- Single gobo holder (non rotating) for WARD type B
- Flight-case for WARD/M
- Flight-case for 6 WARD
- Hook clamp for WARD/M (2 required)
- 1.2 m spotlight safety cable

#### Colour changer for WARD

supplied with :

- 1 16-colour gel filter roll
- 1 adapter plate (APL-CC/WARP)
- 1 DMX/supply cable

Adapter plate for couleur changer

#### Lamps

- G9.5, 800 W, 230 V, 3200 °K axial biplane filament halogen lamp
- G9.5, 600 W, 230 V, 3200 °K axial biplane filament halogen lamp

#### Reference

WARD/12-30  
WARD/22-50  
WARD/12-30/U  
WARD/22-50/U

PFM/185  
GR/185  
SP/2GO/WARP  
SP/OR-GO/WARP  
SP-GO/WARP  
FLY/WARP/M1  
FLY/WARP/6  
A40  
CAS 120/N  
CC/WARP

APL-CC/WARP

800W/G9.5/3200K  
600W/G9.5/3200K

\* Warning: "WARD spotlights are exclusively designed for a biplane filament halogen lamp with a G9.5 base. Any modification to accommodate another lamp is not allowed and would void CE safety approval and product warranty"

# Motorised WARD !

## The Silence of the Rings...



Fully automated Zoom Profiles  
12° - 30° and 22° - 50°

Same Optics as manual WARD  
1733 lux at 12° / 15 m

- Exceptional light output
- 360° endless rotation of shutters and gobos
- Creation of shapes impossible so far
- No pan & tilt reset, **no fans, no noise**
- Pan & Tilt repeatability better than 0.1°
- Patented ring control of all functions via 3-phase stepper motors
- Remote control via DMX512 or Ethernet (ArtNet)
- RDM & ACN ready
- Bidirectional communication and diagnostic via web page on any browser

*No fans ! First condition for silent operation...*



ADB - Your Partner for Light

Belgium N.V. ADB-TTV Technologies S.A.

(Group Headquarters) Leuvensesteenweg 585, B-1930 Zaventem  
Tel : +32.2.709.32.11, Fax : +32.2.709.32.80, E-Mail : [adb@adblighting.com](mailto:adb@adblighting.com)

France ADB S.A.S.

Sales Office: 92, Avenue Jean Jaurès F-92120 Montrouge  
Tel : +33.1.41.17.48.50, Fax : +33.1.42.53.54.76, E-Mail : [adb.fr@adblighting.com](mailto:adb.fr@adblighting.com)

Factory & Group Logistics Centre: Zone industrielle Rouvroy F-02100 Saint-Quentin  
Tel : +33.3.23.06.35.70, Fax : +33.3.23.67.66.56, E-Mail : [adb.fr@adblighting.com](mailto:adb.fr@adblighting.com)

**ADB**  
Lighting Technologies